

DELSTAR

HD BRUSHLESS | SERIES 170

100-17212,-D

28 Volts 200 Amps

PRODUCT SPECIFICATIONS

Part number	100-17212
System Voltage	24V
Rated Output	200A
Output @ 2000 rpm	114A
Ground	Isolated
Mounting	Pad
Rotation	Bidirectional
Temperature limits:	
Low	-40°C / -40°F
High	110°C / 230°F
High	125°C / 257°F (with fresh air intake)
Speed limits:	
	8000 RPM continuous
	9000 RPM intermittent
Coating	Corrosion-Resistant E-Coated
Weight	38 Lbs / 17.4 Kg.
Regulator	Integral
Excitation	Self-excite
Indicator Light	Yes
Remote Sense	Yes
Soft Start Delay (SSD)	Yes
Load Response Control (LRC)	Yes
Overvoltage Shut-Down (OSD)	Yes
Field Short Circuit Protection	Yes
Load Dump Protection	Yes

RECOMMENDED FOR:

- Utility Vehicles
- Marine, Mining
- Industrial
- Construction



100-17212



100-17212-D
with air intake cover

NOTE:

This DelStar 100-17212,-D alternator, meets the marine requirements for Ignition Protection on gas or diesel engines of ISO 8846, USCG, stated in Title 33 CFR 183.410, SAE J1171 and International CE Standards.

PERFORMANCE CURVES

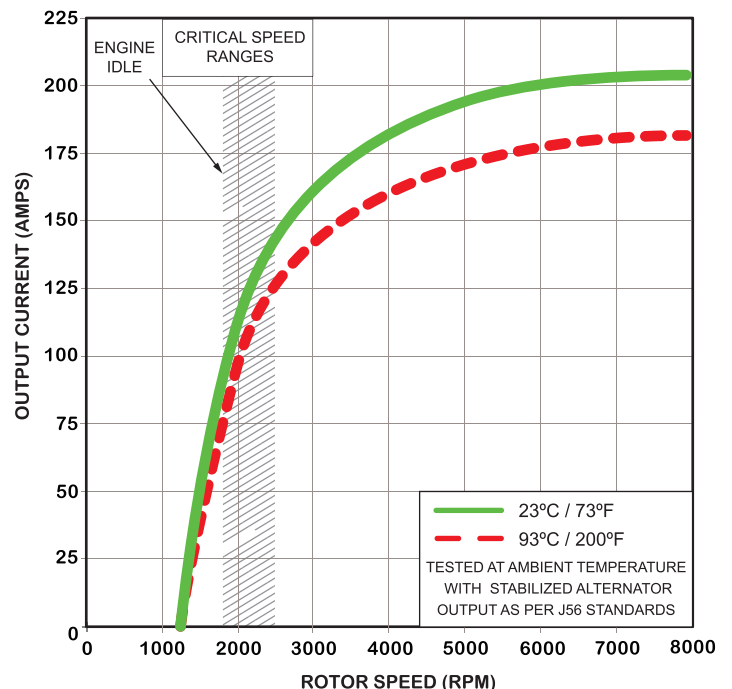

DELSTAR

HD BRUSHLESS | SERIES 170

OUTLINE

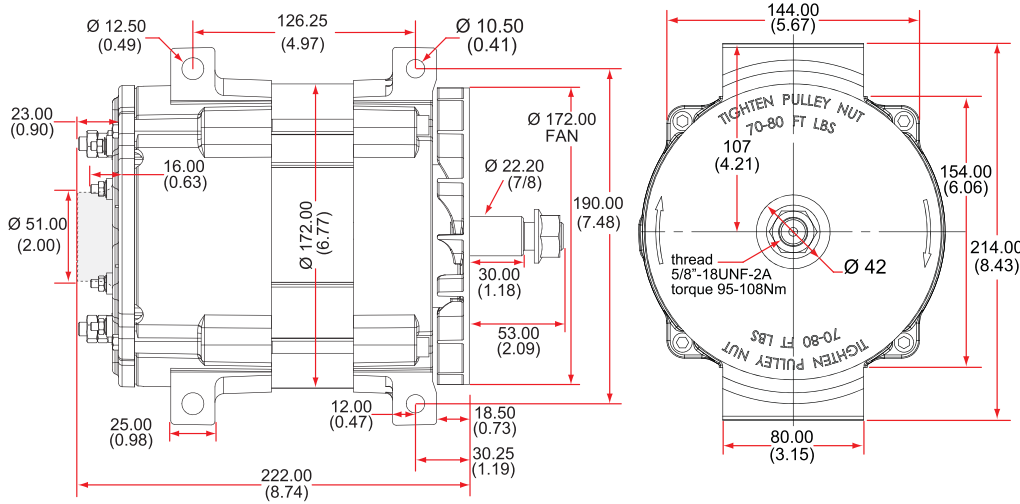

Dimensions are listed in mm over (in)

CONNECTIONS

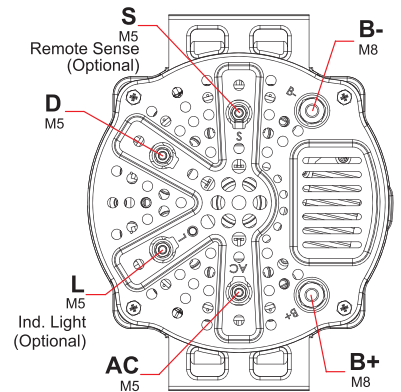

100-17212
 28 Volts 200 Amps

ELECTRICAL SCHEMATIC

